



## DEMO BOARD TEST REPORT

# High Performance Low Cost 24V2A Adapter with Current Mode PWM Controller KP201

### FEATURES

- High Precision 24V CV Regulation with Fast Dynamic Response
- High Efficiency Meet DoE Level VI and CoC V5 Tier2
- Less than 75mW Standby Power
- Very Low Startup and Operation Current
- Multi-Mode Control with Audio Noise Free Operation
- Good EMI Performance
- Built-in Protections with Auto Recovery:
  - VDD Under Voltage Lockout (UVLO)
  - VDD Over Voltage Protection (OVP)
  - On-Chip Thermal Shutdown (OTP)
  - Cycle-by-Cycle Current Limiting
  - Over Load Protection (OLP)
  - Leading Edge Blanking (LEB)

### INTRODUCTION

KP201 is a high performance current mode PWM controller for offline flyback converter applications. The IC has built-in General Primary Side CC control, which simplifies isolated power supply design that requires CC regulation of the output.

In KP201, PWM switching frequency with shuffling is fixed to 65KHz and is trimmed to tight range. The IC has built-in green and burst mode control for light and zero loadings, which can achieve less than 75mw standby power for most applications.

The Demo Board of KP201-D04 is typically designed for the application of 24V/2A with universal input (90-265Vac, 60/50Hz). Besides the multi-protection function, this demo also has very good efficiency, line & load regulation, low standby power loss and meets the EN55022B Conduction and Radiation requirement .

### APPLICATIONS

- Adapter
- Small Home Appliance

### DEMO BOARD SEPCIFICATION

Description	Symbol	Min	Type	Max	Unit	Note
Input Voltage	Vin	90		265	Vac	50/60Hz
Output Voltage	Vout		24		Vdc	
Output Current	Iout		2		A	
Total Output Power	Pout		48		W	
Ripple & Noise	Vripple		136		mVp-p	20MHz Bandwidth @115Vac,1.5m Cable End
System Average Efficiency	$\eta$		>90.75		%	Board End @230Vac
Standby Power Consumption	Pst		71		mW	@265Vac
Startup Time	Tst		2.77		s	Tested at 90Vac/60Hz
Conducted EMI Margin			6		dB	EN55022 Class B
Radiated EMI Margin			6		dB	EN55022 Class B
Surge Test		2			kV	Differential Mode @ 230Vac/50Hz
ESD(Contact)					kV	
EFT					kV	
Safety		Designed to meet UL60950				
Operating Ambient		0		40	°C	
Operating Humidity		5		95	%R.H.	

The table above shows the minimum acceptable performance of the design. Actual performance is listed in the results section.

Demo Board of KP201LG\_D04\_REV1.0

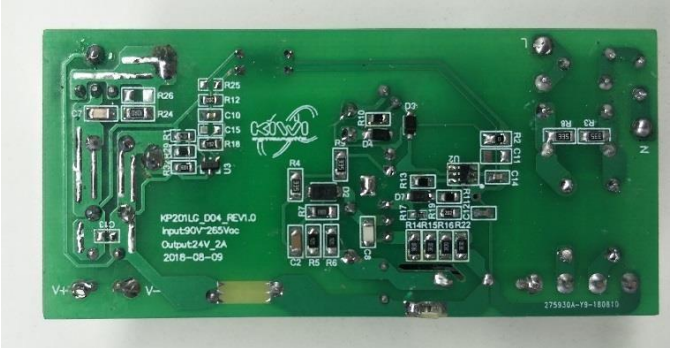

Board Size(in mm): L x W x H=99 x 45 x 26

Schematic

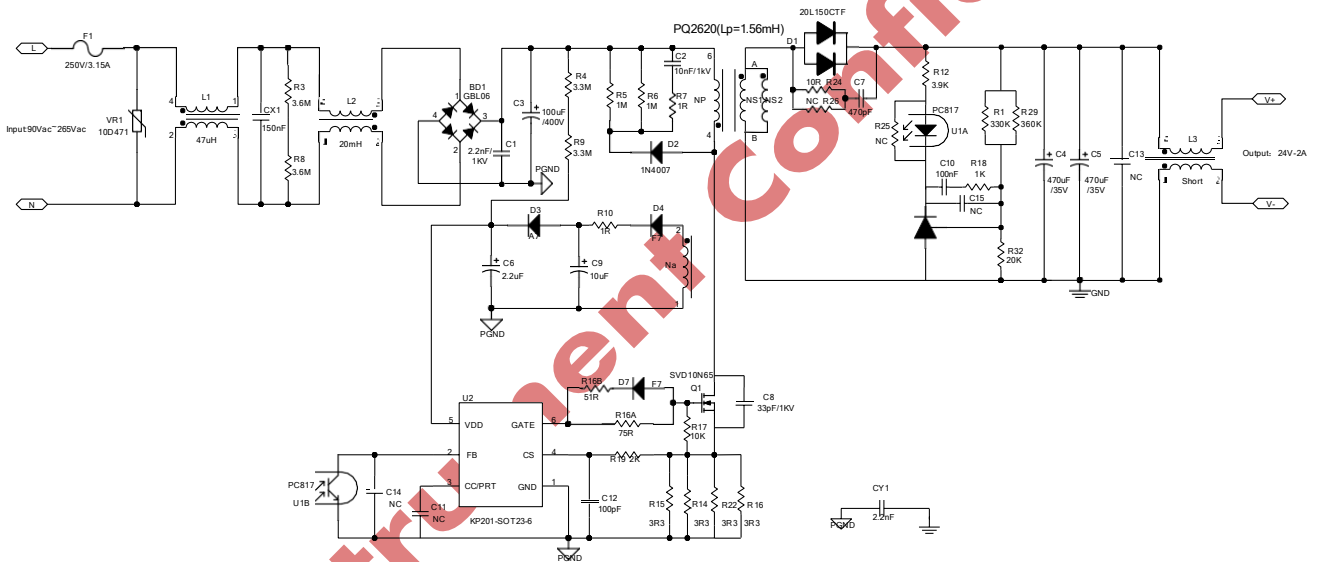

Printed Circuit Board Layout

Top Layer

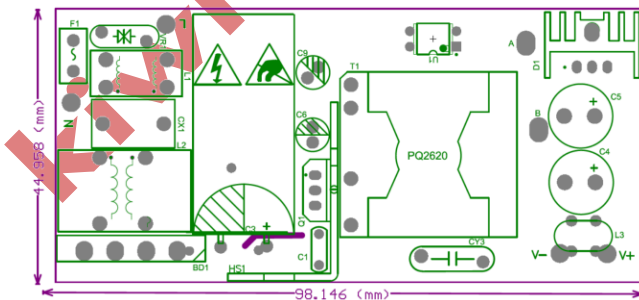

Bottom Layer

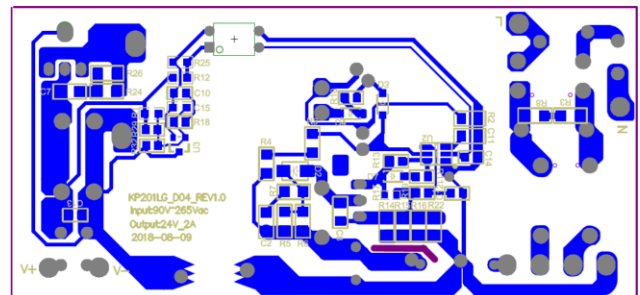



## Circuit Description

The Demo Board of KP201-D04 is configured in a single stage flyback topology, which combines a current mode PWM control regulator KP201LG. KP201-D04 is typically designed for the application of 24V/2A adapter with universal input (90-265Vac, 50/60Hz). Additionally, the demo board can achieve high efficiency, low standby power loss and precise constant voltage control.

### 1. Input Rectification and EMI filtering

The circuit input stage is composed by the components of F1, VR1, L1, CX1, R3, R8, L2 and BD1. F1, VR1, L1 and L2 provide the inrush current limitation and Surge protection in the event of component failure, surge or short circuit event. L1, L2 and CX1 are used to guarantee conducted EMI to meet EN55022B Standard. R3 and R8 are used to discharge the X-Cap CX1. The bridge diode of BD1 rectifies the AC input to DC output, which is followed by a bulk capacitor C3.

### 2. Current Mode PWM Controller KP201 Operation

U2 is the current mode PWM controller KP201, which is used for offline flyback converter applications. The IC has built-in General Primary Side CC control, which simplifies isolated power supply design that requires CC regulation of the output. The CC block is not used on the KP201-D04 demo board. And to make the IC work in CC/CV mode, a capacitor (typically value is 10-47nF) between SEL and GND is needed.

D4, R10, C9, D3, C6, R4 and R9 are used as VDD power supply for KP201. KP201 uses opto-coupler U1, R12, R13, C10, R18 and TL431 to generate FB Pin voltage on primary side to regulate the output voltage within full load range. R14, R15, R16 and R22 are sensing resistors to set maximum output power. C2, D2, R5, R6, R7 compose snubber circuit to depress the drain-source voltage spike.

### 3. Output Voltage Regulation

R18, C10, C15 and U3 TL431 compose output voltage regulation network. R1, R29 and R32 are the output voltage resistor dividers for TL431's reference compare. C4 and C5 are the output capacitors used to supply output current and lower output voltage ripple.



Bill of Material

No.	Designator	Value	Description	Package	Manufacturer	Part Number
1	BD1	GBU406	4.0A GLASS PASSIVATED BRIDGE RECTIFIER	TH	DIODES	GBU406
2	C1	2.2nF/1kV	Ceramic Cap, 1kV X7R	1206	Murata	
3	C2	10nF/1kV	Ceramic Cap, 1kV X7R	1206	Murata	
4	C3	100uF/400V	Electrolytic Cap, 400V, 16*35	TH	Aishi	
5	C4	470uF/35V	Electrolytic Cap, 35V, 10*16	10*16	NXA	470uF/35V
6	C5	470uF/35V	Electrolytic Cap, 35V, 10*16	10*16	NXA	470uF/35V
7	C6	2.2uF	Electrolytic Cap, 16V, 10*16	TH	jianghai	
8	C7	470PF/1KV	Ceramic Cap, 1kV X7R	1206	Murata	
9	C8	33PF/1KV	Ceramic Cap, 1kV X7R	1206	Murata	
10	C9	10uF	Electrolytic Cap, 16V, 10*16	TH	jianghai	
11	C10	100n	Ceramic Cap, 25V X7R	0805	TDK	
12	C11	NC	Ceramic Cap, 50V NPO	0805	Murata	
13	C12	100pF	Ceramic Cap, 50V NPO	0805	Murata	
14	C13	NC	Ceramic Cap, 50V X7R,0805	0805	Murata	
15	C14	NC	Ceramic Cap, 50V NPO	0805	Murata	
16	C15	NC	Ceramic Cap, 25V X7R	0805	TDK	
17	CX1	150n	MKP62,275Vac~X2,P=10mm, T=8mm	TH	Fala	
18	CY3	2.2nF	Y1Cap,400VAC, P=10mm,T=5.0mm	TH	STE	
19	D1	150V/20A	Schottky Rectifier (VF=0.686V@IF=10A)	ITO-220AB	PFC Device	20L150CTF
20	D2	1KV/1A	1.0 AMP SILICON RECTIFIERS	SMA	Any	M7
21	D3	A7	Fast Recovery Rectifiers	SOD123	YEA SHIN	A7
22	D4	F7	Fast Recovery Rectifiers	SOD123	YEA SHIN	FF1MS
23	D7	F7	Fast Recovery Rectifiers	SOD123	YEA SHIN	FF1MS
24	F1	250V/2A	Fuse 250V/1A	TH	Any	
25	L1	47uH	WE-744841247	XS	Wurth Elektronik	744841247
26	L2	20mH	NiZn T16*12*8,Magnet Wire:0.5mm	TH	Any	T16*8*7
27	L3	NC	COMMON CHOKE			
28	Q1	SVD10N65F	N Mosfet, 650V/10A, Rdson=0.84ohm	TO-220	Silan	SVD10N65F
29	R1	330K	Film Resistor, 5%	0805	Yageo	
30	R2	0R	Film Resistor, 1%	1206	Yageo	
31	R3	3.6M	Film Resistor, 5%	1206	Yageo	
32	R4	3.3M	Film Resistor, 5%	1206	Yageo	
33	R5	1M	Film Resistor, 5%	1206	Yageo	



High Performance 24V2A Adapter with Current Mode PWM Controller

34	R6	1M	Film Resistor, 5%	1206	Yageo	
35	R7	1R	Film Resistor, 5%	1206	Yageo	
36	R8	3.6M	Film Resistor, 5%	1206	Yageo	
37	R9	3.3M	Film Resistor, 5%	1206	Yageo	
38	R10	1R	Film Resistor, 5%	0805	Yageo	
39	R11	51R	Film Resistor, 5%	0805	Yageo	
40	R12	3.9K	Film Resistor, 5%	0805	Yageo	
41	R13	75R	Film Resistor, 5%	0805	Yageo	
42	R14	3R3	Film Resistor, 1%	1206	Yageo	
43	R15	3R3	Film Resistor, 1%	1206	Yageo	
44	R16	3R3	Film Resistor, 1%	1206	Yageo	
45	R17	10K	Film Resistor, 5%	0805	Yageo	
46	R18	1K	Film Resistor, 5%	0805	Yageo	
47	R19	2K	Film Resistor, 5%	0805	Yageo	
48	R22	3R3	Film Resistor, 1%	1206	Yageo	
49	R24	10R	Film Resistor, 1%	1206	Yageo	
50	R25	NC	Film Resistor, 5%	0805	Yageo	
51	R26	NC	Film Resistor, 1%	1206	Yageo	
52	R29	360K	Film Resistor, 5%	0805	Yageo	
53	R32	20K	Film Resistor, 5%	0805	Yageo	
54	T1	Lm=1.56mH	Bobbin, PQ26/20, Vertical, 12 pins , PC40, Transformer	PQ2620, Vertical, 12 Pins	TDG	
55	U1	None	4 Pin DIP Photo-Transistor Photocoupler	DIP4	Everlight	EL817
56	U2	KP201	Secondary Side Regulation CC/CV Controller	SOT-23-6	Kiwi Instruments	KP201
57	U3	None	Plastic-Encapsulate Adjustable Reference Source	SOT-23	Hottech	TL431
58	VR1	10D471	ZnO VARISTOR, P=5.0mm, T=3.5mm	10D	STE	STE10D471K 1BN0FSB0
59	RH Type Bead Cores	None	For Cathode of D1	RH3.5*3*1.5	Any	

## Transformer Manufacture Guide

### 1. Electrical Diagram

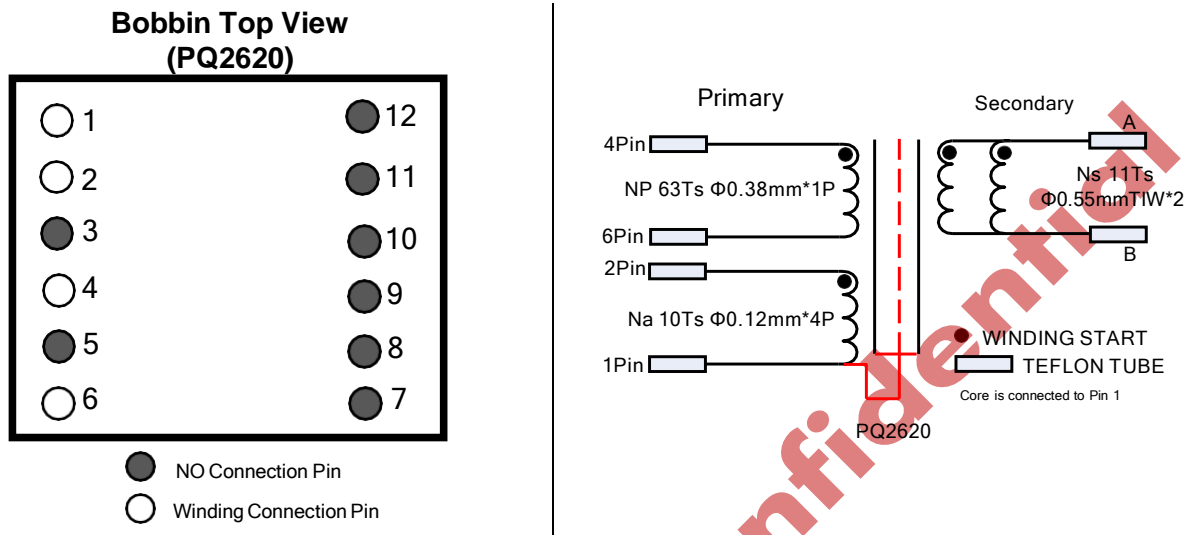

### 2. Winding Diagram

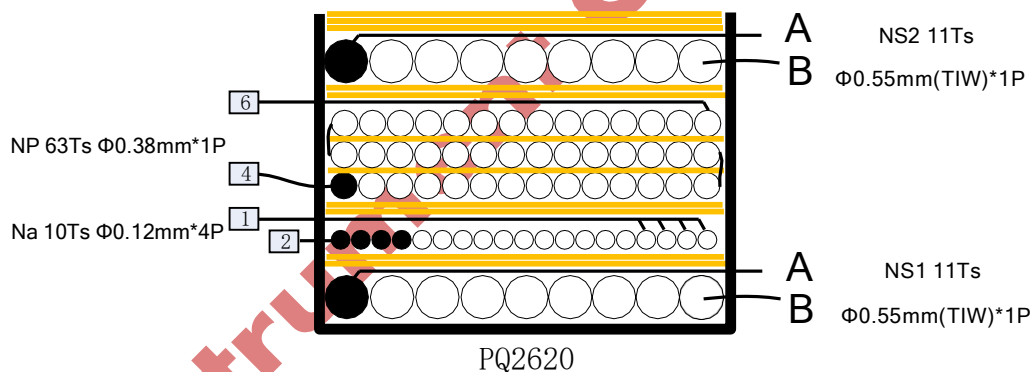

### 3. Winding Order

Number	Winding	Layer	Start	End	Wire Size(mm)	Turns	Note
1	NS1	Secondary	A	B	0.55(TIW)*1P	11Ts	Close Wound
2	Na	Auxiliary	2	1	0.12*4P	10Ts	Close Wound
3	NP	Primary	4	6	0.38*1P	63Ts	Close Wound
4	NS1	Secondary	A	B	0.55(TIW)*1P	11Ts	Close Wound



#### 4. Electrical Specification

Items	Test Condition	Test Pin	Specification
Primary Inductance	Measured at 40kHz, 1.0 VRMS	Pins 4 - 6; other windings open	1.56mH±5%
Leakage Inductance	Measured at 40kHz, 1.0 VRMS	Pins 4 - 6; all other windings shorted	10uH
HI-POT HV Test	3000Vac/50Hz, One minute	Primary to Secondary	3000Vac, 5mA
	1500Vac/50Hz, One minute	Primary to Core	1500Vac, 5mA
	1500Vac/50Hz, One minute	Secondary to Core	1500Vac, 5mA
Insulation Resistance	500Vdc	All windings to core	100M Ω Min
	500Vdc	Between windings	100M Ω Min
DC Resistance	-	Pins 4 - 6	2R Max

#### 5. BOM

Items	Spec
Core	PQ2620, PC40 or equivalent
Bobbin	PQ2620, 6+6Pin
Wire	Φ0.38mm, 2UEW, Class B; Φ0.12mm, 2UEW, Class B; Φ0.55mm TIW;
Tape	9.5mm(W)×0.06mm(TH)

**Test Result**

**1. Input characteristics**

**1.1 Maximum rated input AC current**

**Standard:** 2Amax. @ 90Vac input & full load

**Result:** Pass

VIN(AC)	90Vac	lin_max limit(A)	<b>Result</b>
Iout	1.17A	2A	<b>PASS</b>

**1.2 Inrush current (cold start)**

**Standard:** 30Amax. @ 265Vac input

**Result:** Pass

VIN(AC)	Iinrush	lin_max limit(A)	<b>Result</b>
265Vac	19.2A	30A	<b>PASS</b>

**Waveforms:**

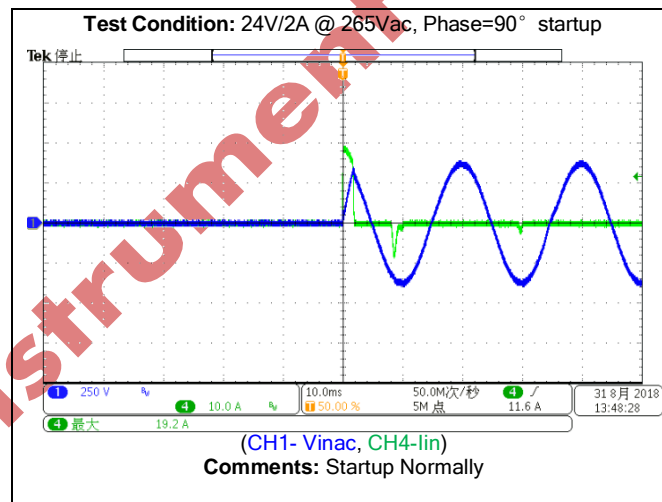

**1.3 No load input power dissipation**

**Standard:** while input 90Vac~265Vac and the output is no load, the input power loss must be less than 75mW.

**Result:** Pass

VIN(AC)	90	115	230	265	green mode limit(A)	<b>Result</b>
Pin	38	41	62	71	75mW	<b>PASS</b>



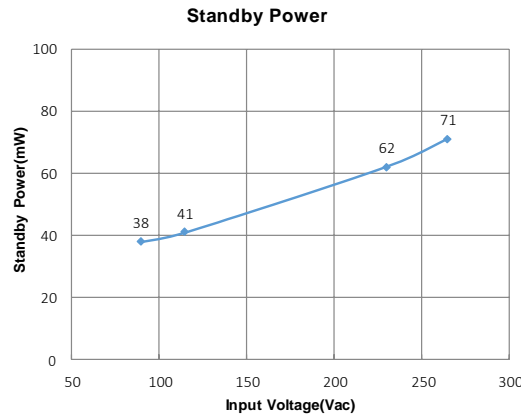

1.4 Average efficiency

**Standard:** The average efficiency tested on board end meets CoC V5 tier 2 with 2% margin @115Vac and 230Vac, CoC V5 requirement for 24V2A system is 88.97%.

**Result:** Pass

Vin(Vac)	Fline(Hz)	Pin(W)	Vout(V)	Iout(A)	Pout(W)	Eff(%)	Eff_AVG(%)	CoC V5(%)
90	60	5.44	24.23	0.2	4.846	89.08	/	78.97
		13.50	24.23	0.5	12.115	89.74	89.77	88.97
		26.92	24.22	1	24.22	89.97		
		40.34	24.21	1.5	36.315	90.02		
		54.16	24.2	2	48.4	89.36		
115		5.44	24.24	0.2	4.848	89.12	/	78.97
		13.40	24.23	0.5	12.115	90.41	90.70	88.97
		26.52	24.23	1	24.23	91.37		
		40.10	24.21	1.5	36.315	90.56		
		53.50	24.2	2	48.4	90.47		
230	50	5.64	24.23	0.2	4.846	85.92	/	78.97
		13.61	24.22	0.5	12.11	88.98	90.75	88.97
		26.58	24.22	1	24.22	91.12		
		39.48	24.22	1.5	36.33	92.02		
		53.25	24.2	2	48.4	90.89		
265		5.73	24.23	0.2	4.846	84.57	/	78.97
		13.54	24.23	0.5	12.115	89.48	90.03	88.97
		27.12	24.21	1	24.21	89.27		
		40.06	24.2	1.5	36.3	90.61		
		53.31	24.19	2	48.38	90.75		

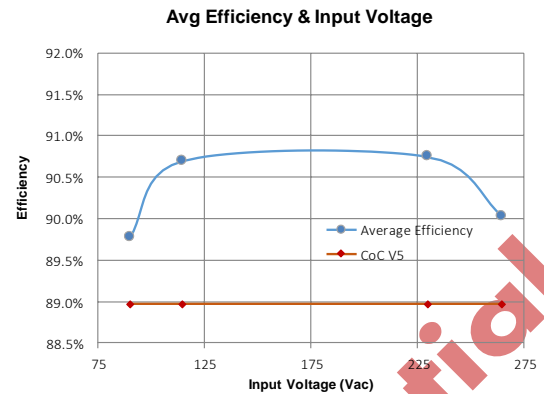
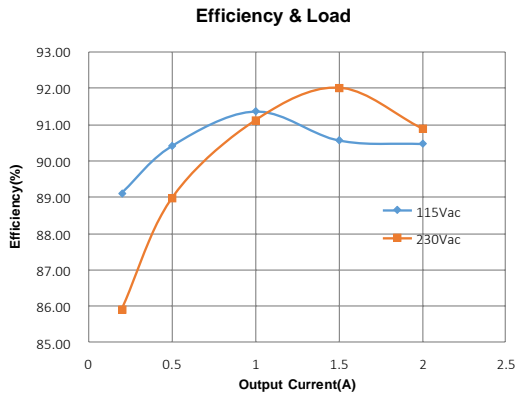

## 2. Output characteristics

### 2.1 Output line regulation and load regulation

**Standard:** under the input voltage 90Vac~265Vac, Line regulation <6%, Load regulation <6%. The output voltage was tested at 1.5m AWG20 cable end.

**Result:** Pass

Input Voltage	Output Voltage(V)					Load Regulation
	0% Load	25% Load	50% Load	75% Load	Full Load	
90Vac/60Hz	24.2	24.14	24.07	24.0	23.91	1.21%
115Vac/60Hz	24.2	24.14	24.05	24	23.94	1.09%
230Vac/50Hz	24.2	24.14	24.06	24.01	23.93	1.13%
264Vac/50Hz	24.2	24.12	24.06	24.0	23.93	1.13%
<b>Line Regulation</b>	0.00%	0.08%	0.08%	0.04%	0.13%	

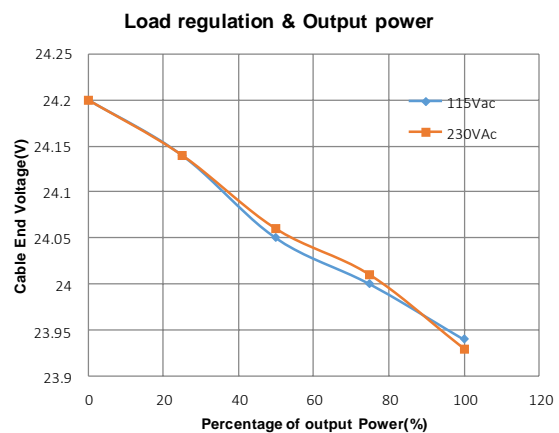
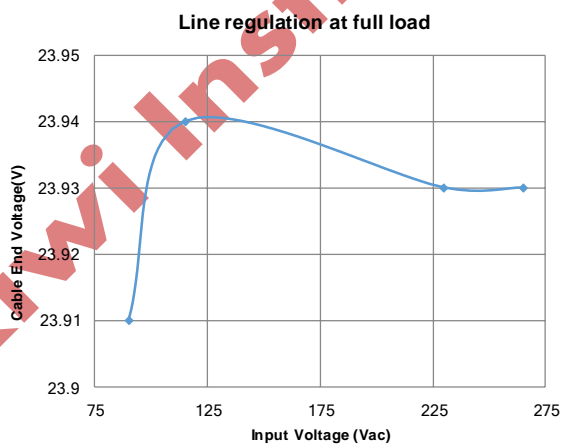

### 2.2 Ripple & noise

**Standard:** under the input voltage 90Vac~265Vac, Vripple\_max<150mVpp



Result: Pass

Note: Ripple & noise were measured at AWG 20 cable end with a 0.1uF/50V ceramic cap connected in parallel with a 10uF/50V electrolytic cap. Bandwidth was limited to 20Mhz.

Input Voltage	Ripple & noise	
	No Load(mV)	Full Load(mV)
90Vac/60Hz	44	150mv
115Vac/60Hz	44	136mv
230Vac/50Hz	46	106mv
264Vac/50Hz	54	110mv

Waveforms (115Vac & 230Vac):

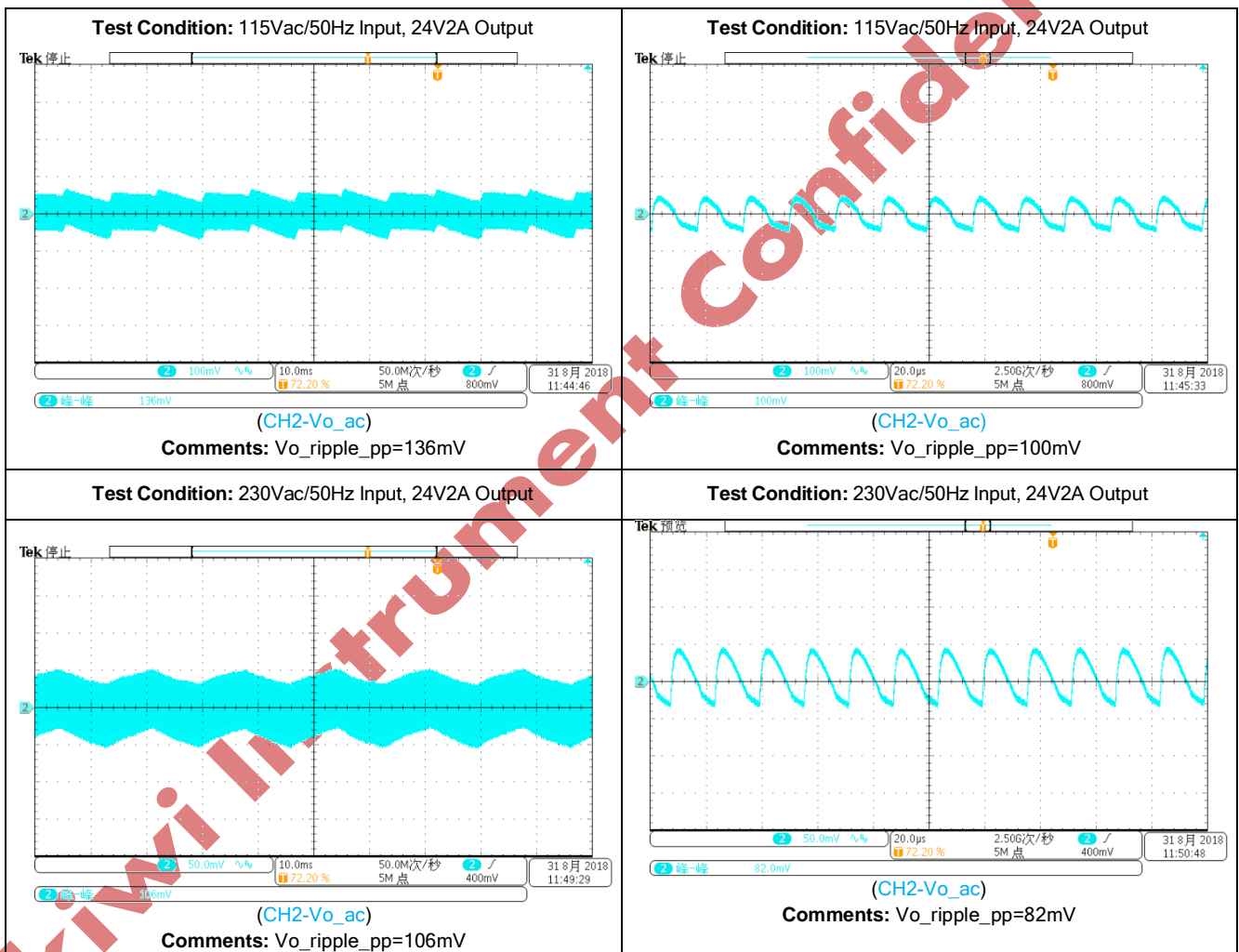



High Performance 24V2A Adapter with Current Mode PWM Controller

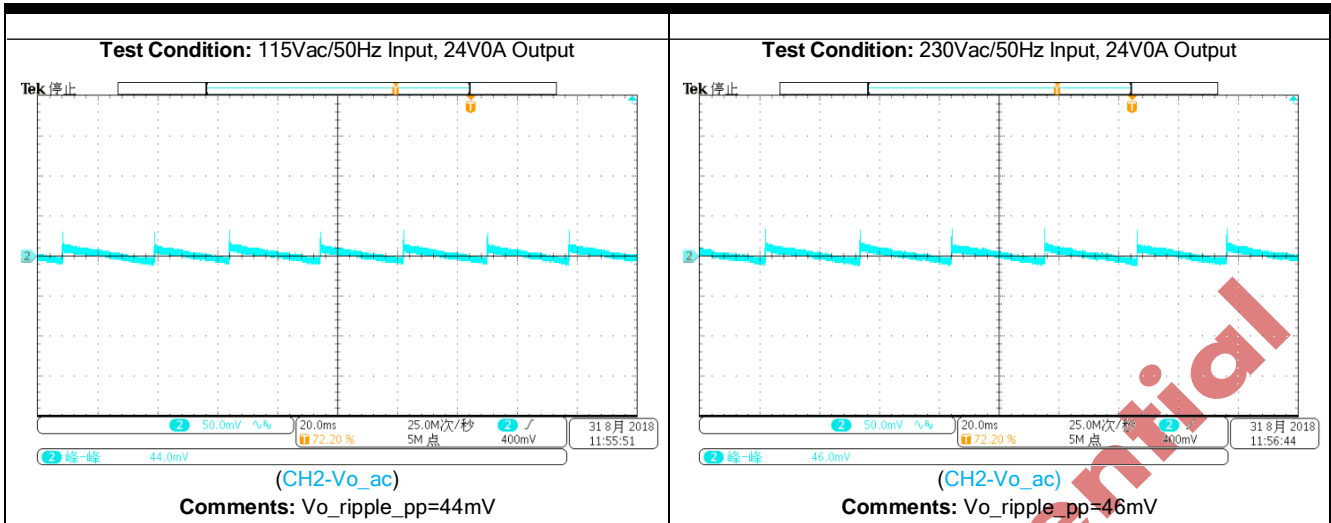

2.3 Load Transient Test

**Standard:** under the input voltage 90Vac~265Vac, the output Voltage transient response should be within  $\pm 10\%$  normal voltage.

**Result:** Pass

**Note:** 1.10% load shift to 90% load with 0.25A/us changing ramp and 100Hz changing frequency.

Input Voltage	Output Voltage(~ac)	Remark
90Vac/60Hz	632mV	Pass
115Vac/60Hz	632mV	Pass
230Vac/50Hz	600mV	Pass
264Vac/50Hz	600mV	Pass

Waveforms:

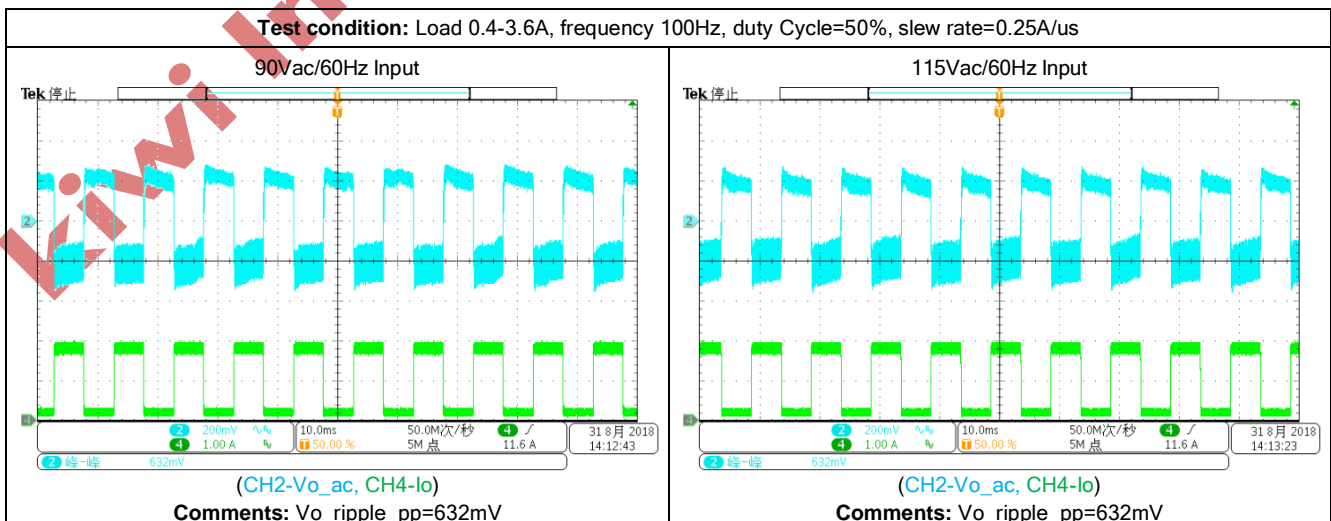

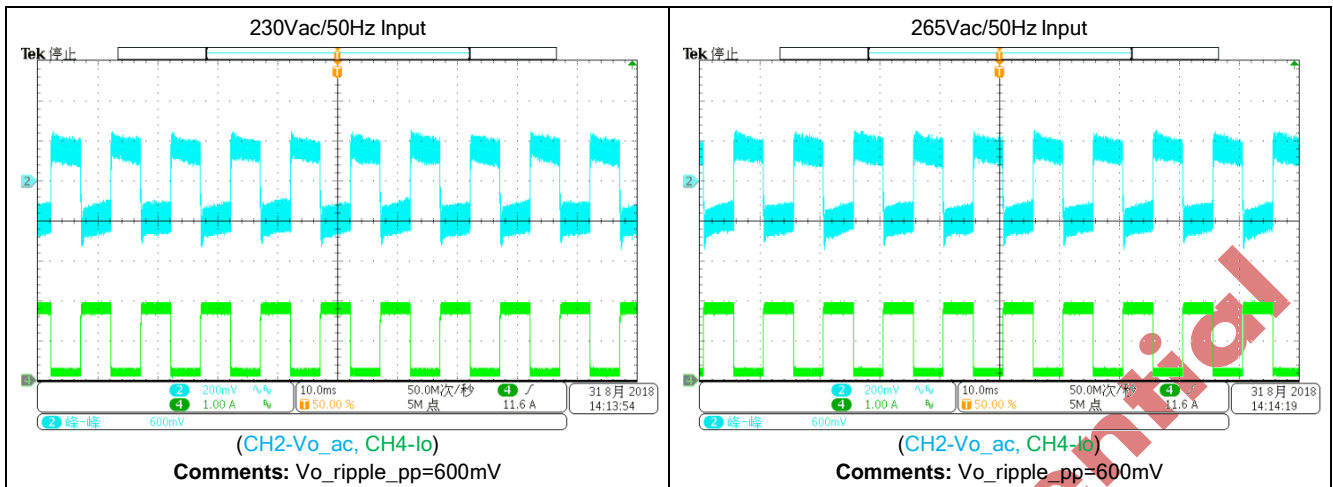

### 2.4 Capacitive Load Startup Test

**Standard:** while capacitance load is 470uF, the power supply can turn on normally and the output is in the rated range.

**Result:** Pass

**Waveforms:**

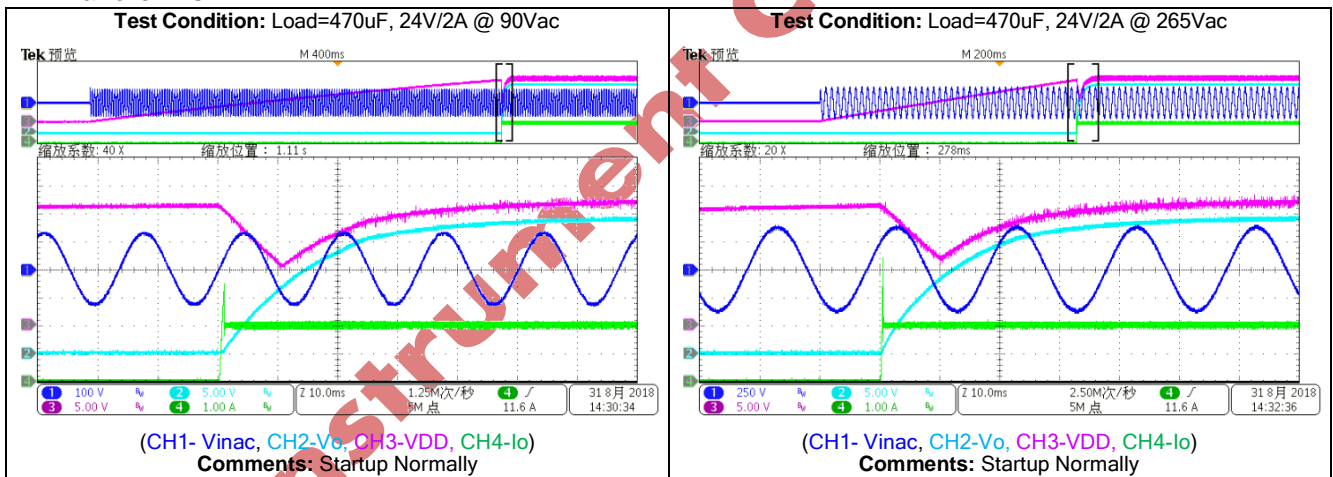

### 2.5 Startup Time and Holdup Time

**Standard:** 1.the startup time should be less than 3s @90Vac. 2. The holdup time should be larger than 10ms @115Vac;

**Result:** Pass

Item	Input Voltage	Test Data	Remark	Note
Startup Time	90Vac	2.77s	Pass	Full Load
Holdup Time	115Vac	15.8ms	Pass	Cut off the Vac while Vbus voltage reached the lowest voltage

Waveforms:

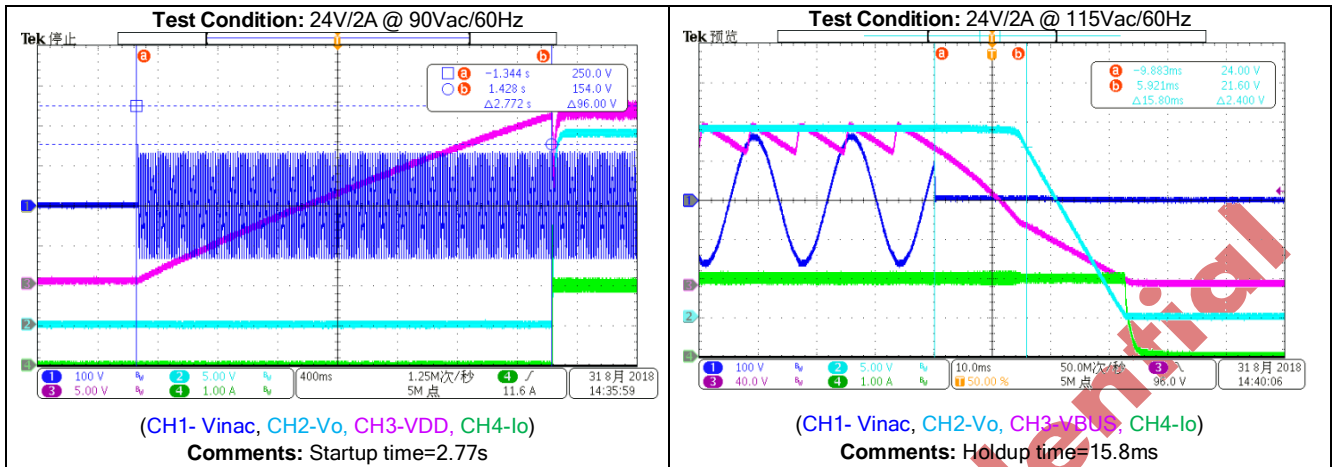

2.6 Output Voltage Rise Time and Fall Time

Standard: Under full load test, the output voltage rise time should be less than 50ms and the fall time should be less than 20ms.

Result: Pass

Input Voltage	Load	Item	Test Result	Note
90Vac/60Hz	Full Load	Trise	35.4ms	No overshoot
		Tfall	16.76ms	No undershoot
264Vac/50Hz	Full Load	Trise	6.04ms	No overshoot
		Tfall	21.1ms	No overshoot
264Vac/50Hz	No Load	Trise	21.1ms	No overshoot
		Tfall	18.05ms	No undershoot
	No Load	Trise	5.86ms	No overshoot

Waveforms:

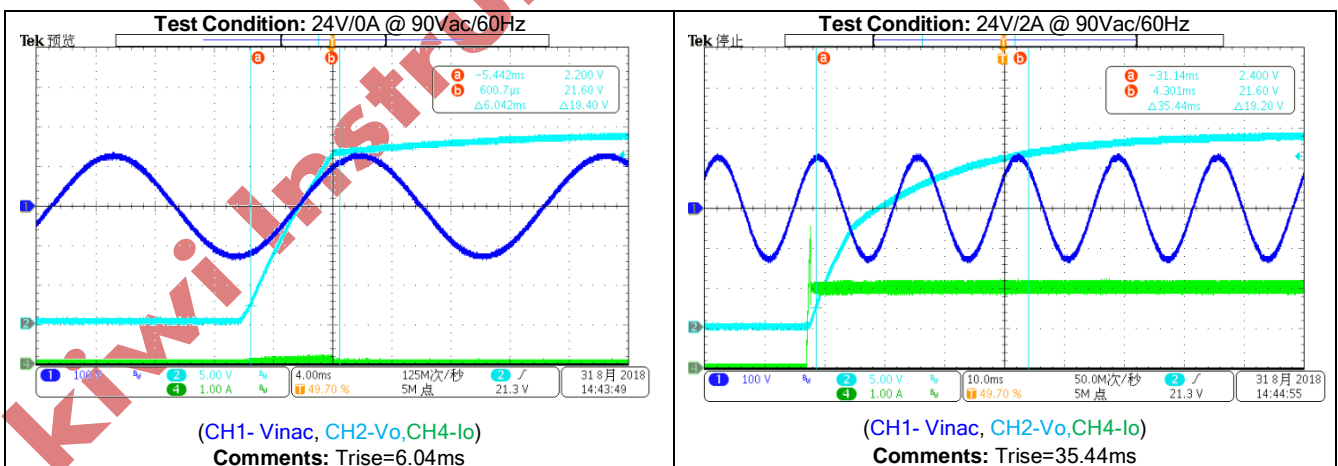

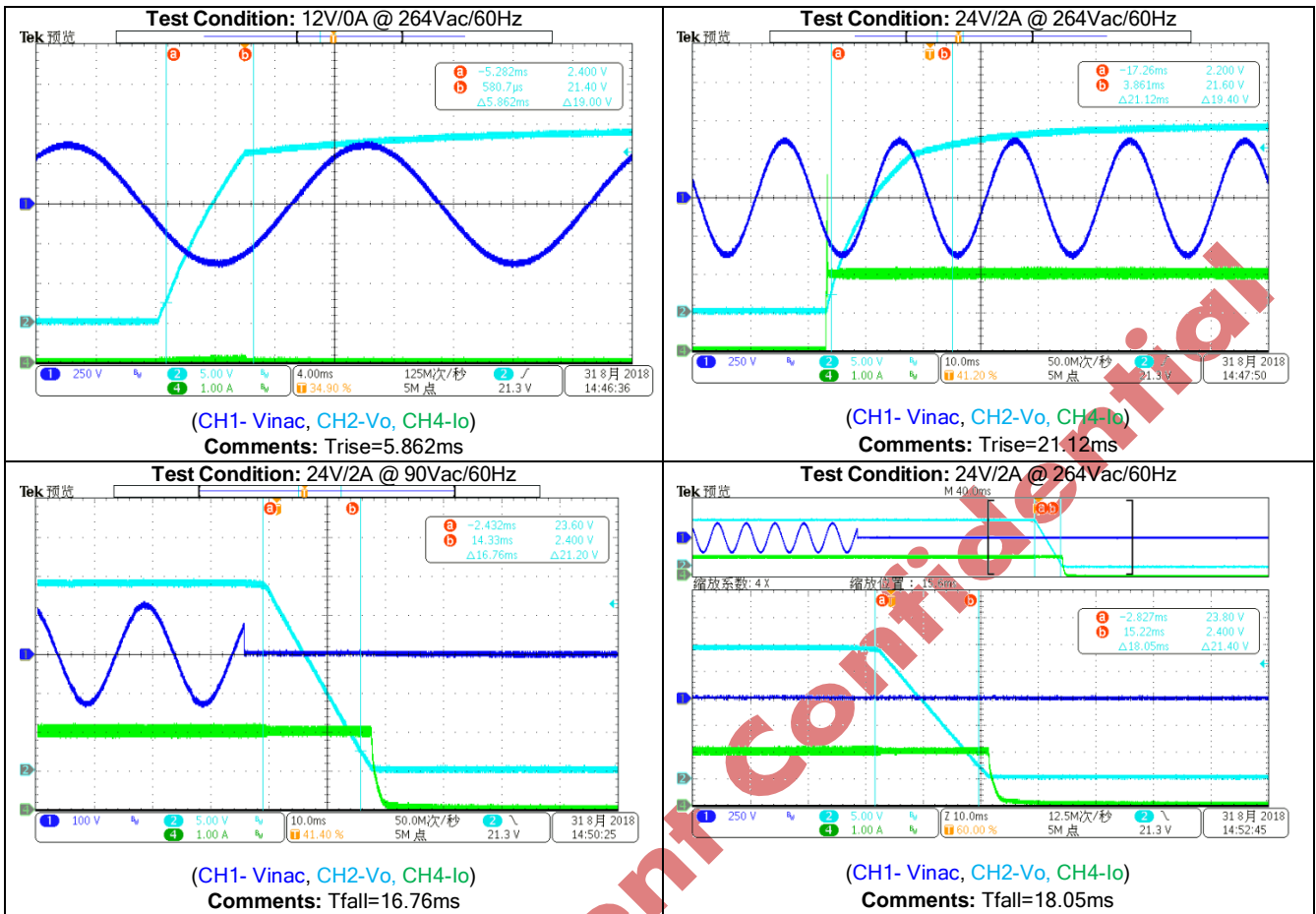

### 3. Protection Test

#### 3.1 Over current protection

**Standard:** OCP point limited is between 110%~130% full load current.

**Result:** Pass

Input Voltage(Vac)	90	115	180	230	265	Remark
OCP Current(A)	2.38	2.58	2.55	2.45	2.45	Pass

Maximum Output Current & Input Voltage

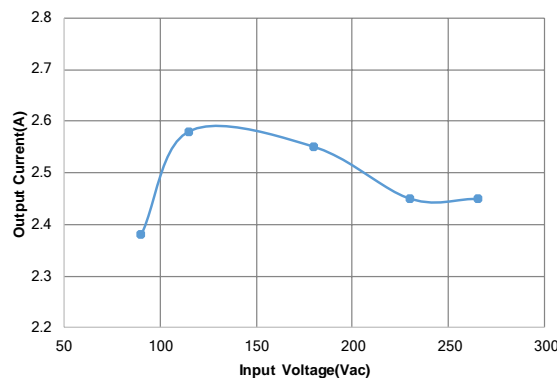

### 3.2 Short circuit protection

**Standard:** the power supply must shut-down in the event of a short circuit and automatically return to normal operating condition once the fault condition has been removed. And the peak input power should be less than 5W.

**Result:** Pass

**Test Data:**

Input Voltage(Vac)	90	115	230	265	<b>result</b>
Pin(W)	0.38	0.47	1.03	1.32	<b>PASS</b>

**Waveforms:**

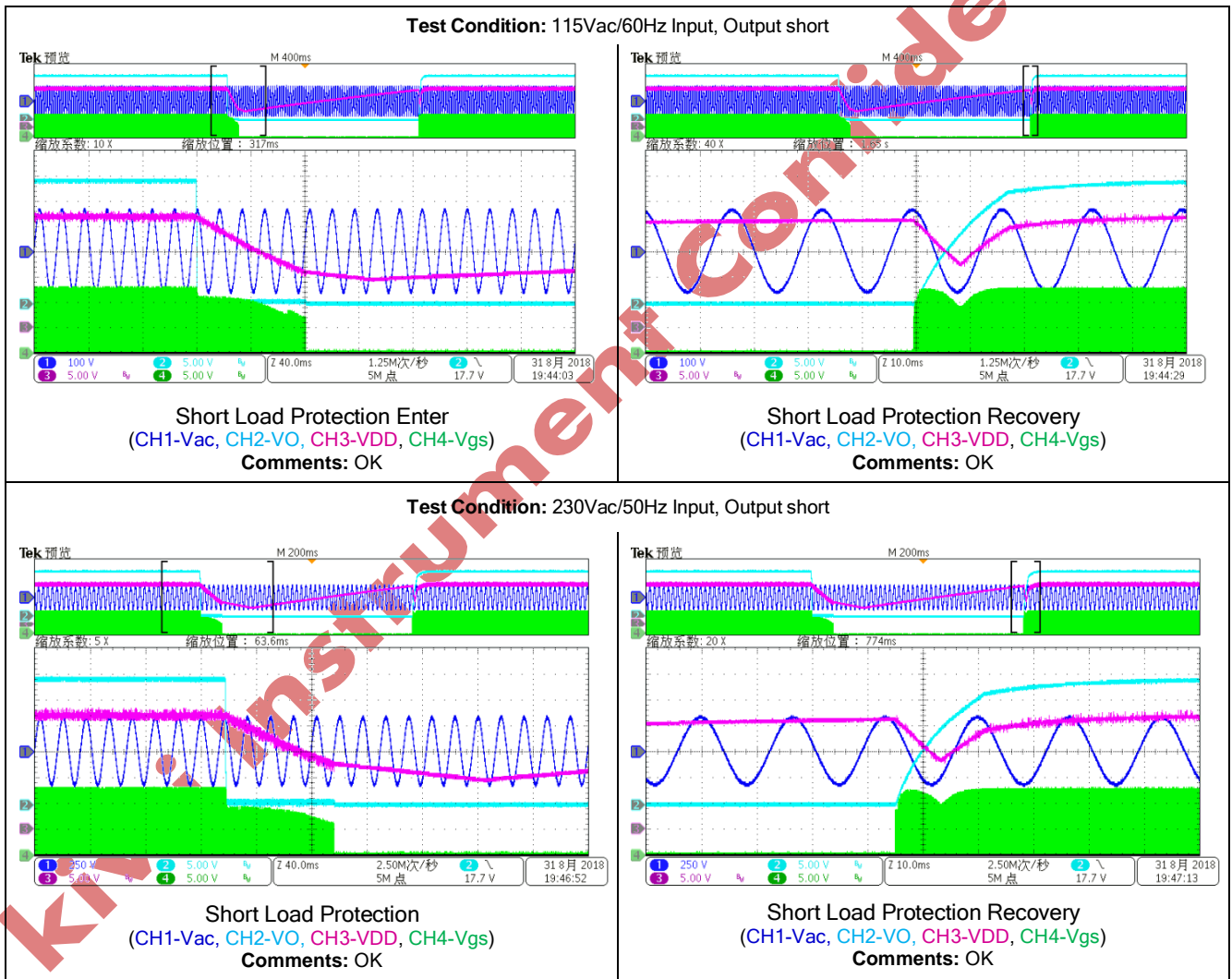

### 3.3 Over voltage protection

**Standard:** OVP point limit: <150%.

**Result:** Pass

**Waveforms:**



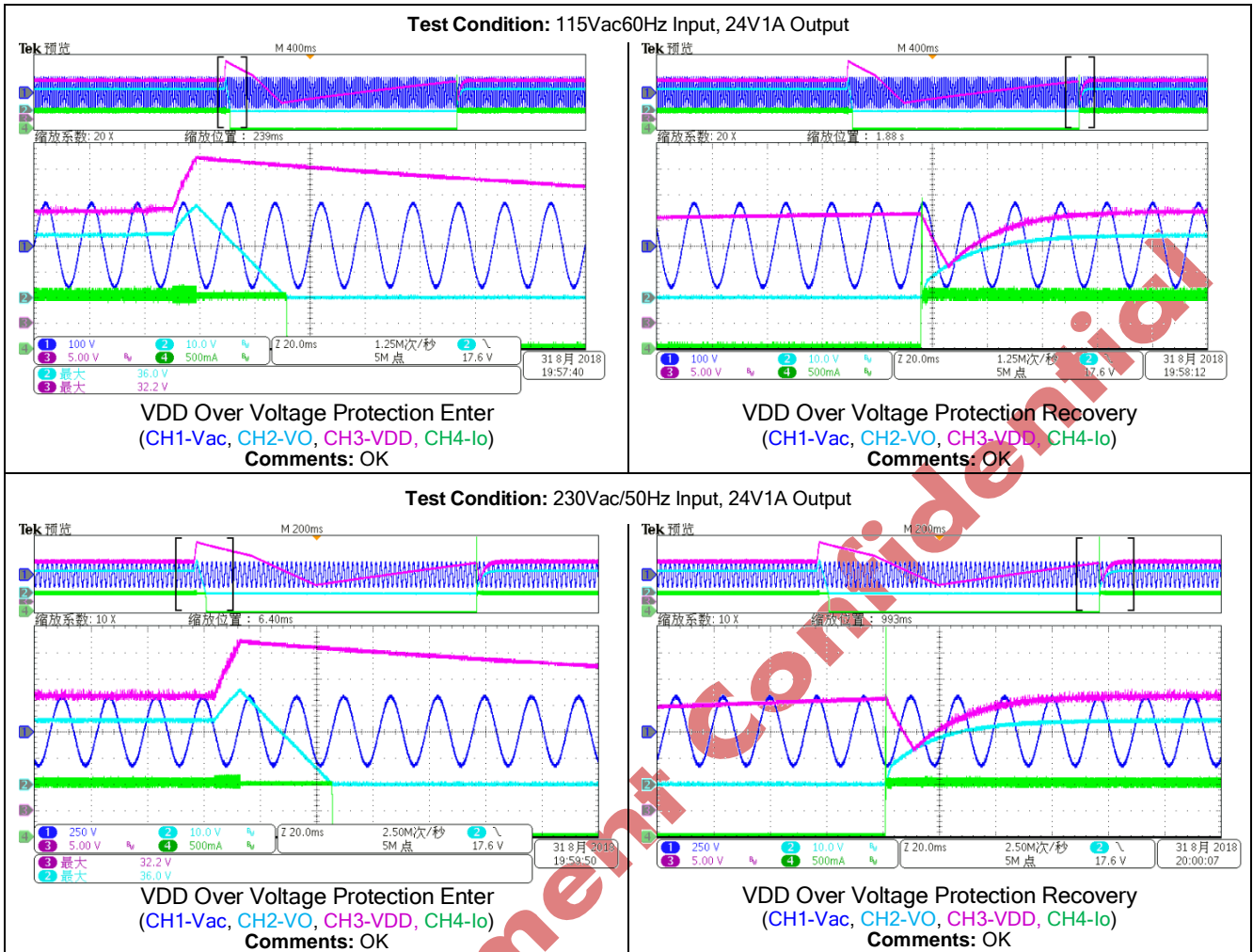

#### 4. Reliability requirements

##### 4.1 Device Maximum Rating Test

Standard: MOSFET and Diode < 95% V<sub>rrm</sub>; B<sub>max</sub> < 0.3T.

Result: Pass

Input Voltage	Component	Test Condition	Test Result	Note
264Vac/50Hz	Q1 SVF10N65F	Startup	568V	Pass
		Steady State	568V	Pass
		Output Short	564V	Pass
	D1 20L150CTF	Startup	108V	Pass
		Steady State	108V	Pass
		Output Short	107V 11.8A	Pass
	Transformer Core	Startup	0.296T	Pass
		Steady State	0.28T	Pass

Waveforms:

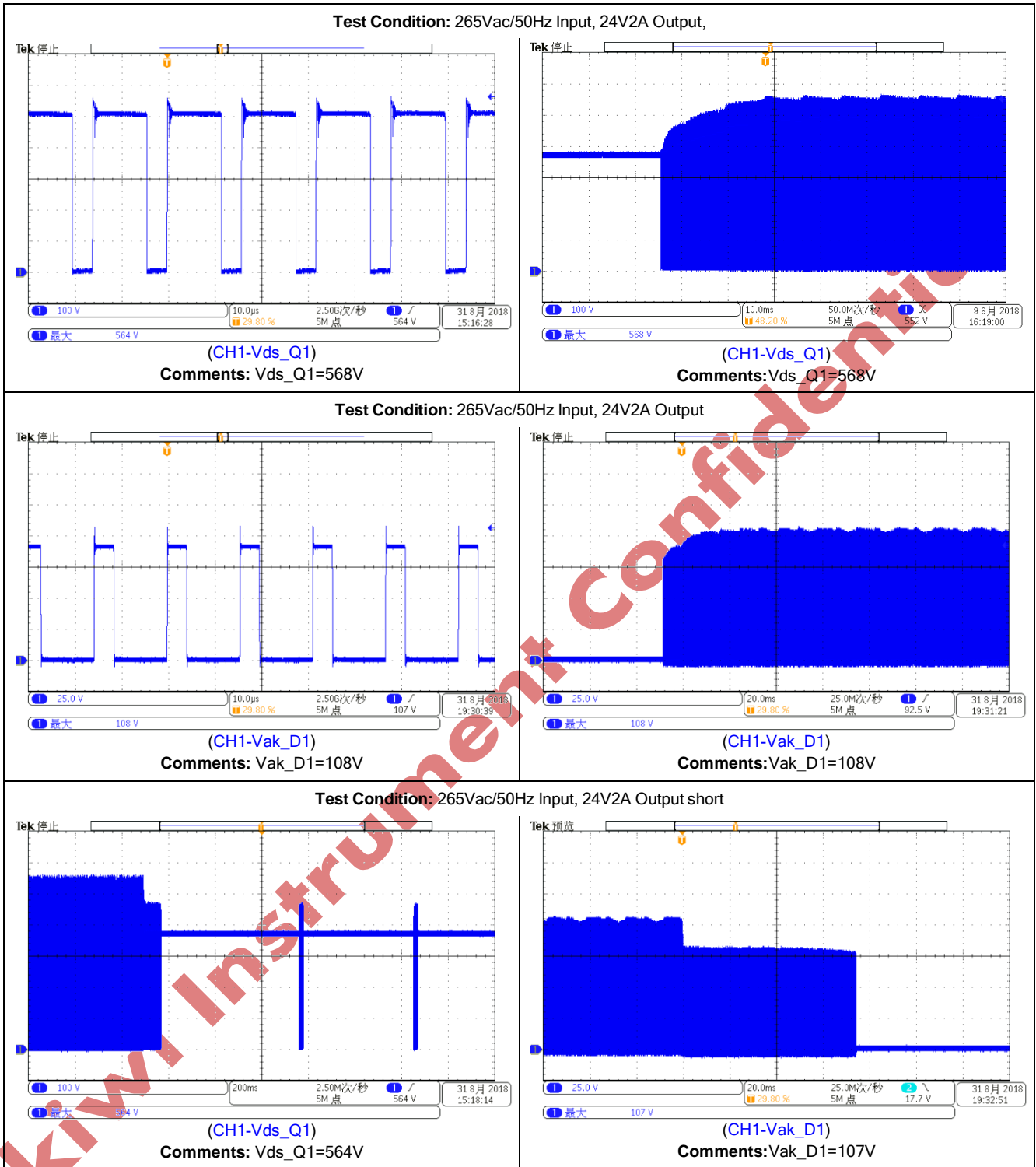

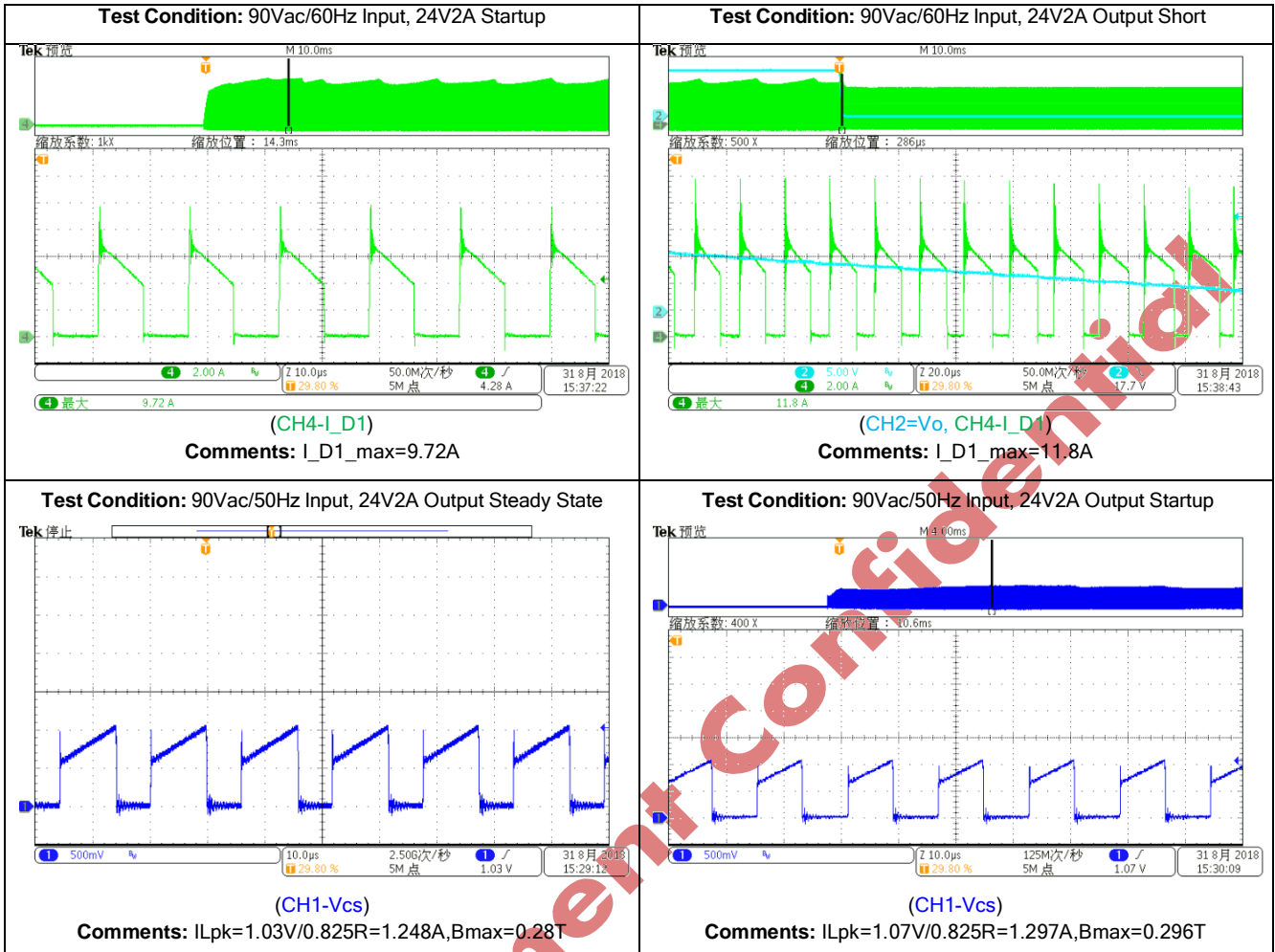

Confidential

### 4.2 Thermal Test

**Standard:** MOS, IC and Diode:  $T_a=40^{\circ}\text{C}$ ,  $\Delta T<75^{\circ}\text{C}$ . Transformer:  $T_a=40^{\circ}\text{C}$ ,  $\Delta T<70^{\circ}\text{C}$ .

**Result:** Pass

**Test Condition:** 90Vac/60Hz, 265Vac/50Hz; 24V2A output; Burn-in 1Hour @ confined container (19cm\*17cm\*10cm cardboard box) and steady environment with no airflow,  $T_a$  is the temperature inside the cardboard box.

Component	90Vac		265Vac	
	$T_a=40.01^{\circ}\text{C}$		$T_a=32.9^{\circ}\text{C}$	
	T( $^{\circ}\text{C}$ )	Trise( $^{\circ}\text{C}$ )	T( $^{\circ}\text{C}$ )	Trise( $^{\circ}\text{C}$ )
Q1 SVD10N65F	82.7	42.69	75.9	43
D1 20L150CTF	85.4	45.39	83.9	51
T1 Core	63.6	23.59	64	31.1
T1 Wire	73.9	33.89	71.9	39
BD1 GBL06	79.8	39.79	51.5	18.6

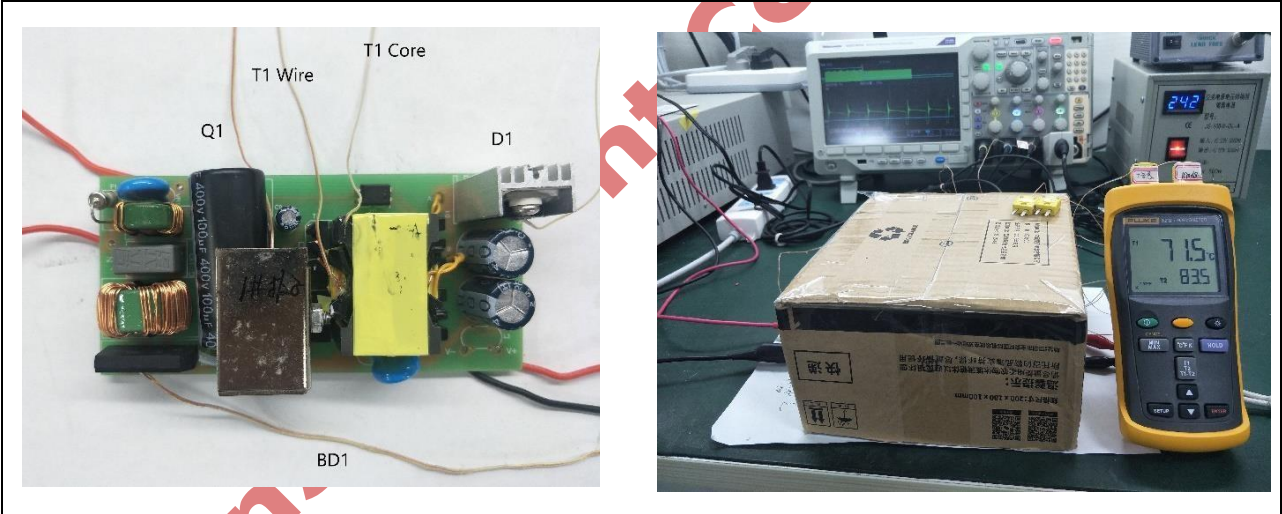

Kiwi In

nt Confidential

### 5. EMC/EMS Test Result

Standard:

standard	EN55022B/55032B
content	CE & RE
requirement	6dB margin

#### 5.1 Conducted Emissions

Result: Pass

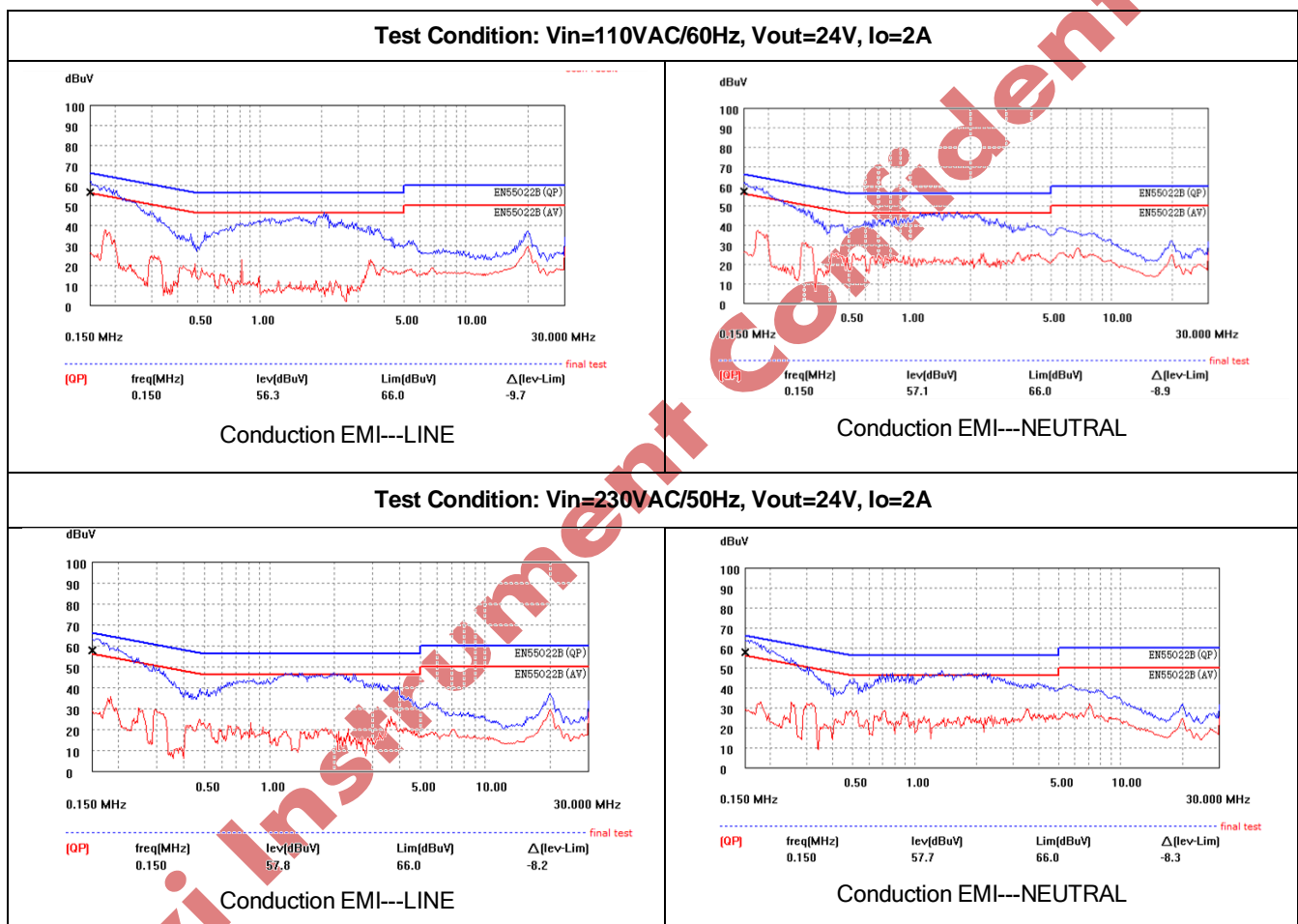

### 5.2 Radiated Emissions

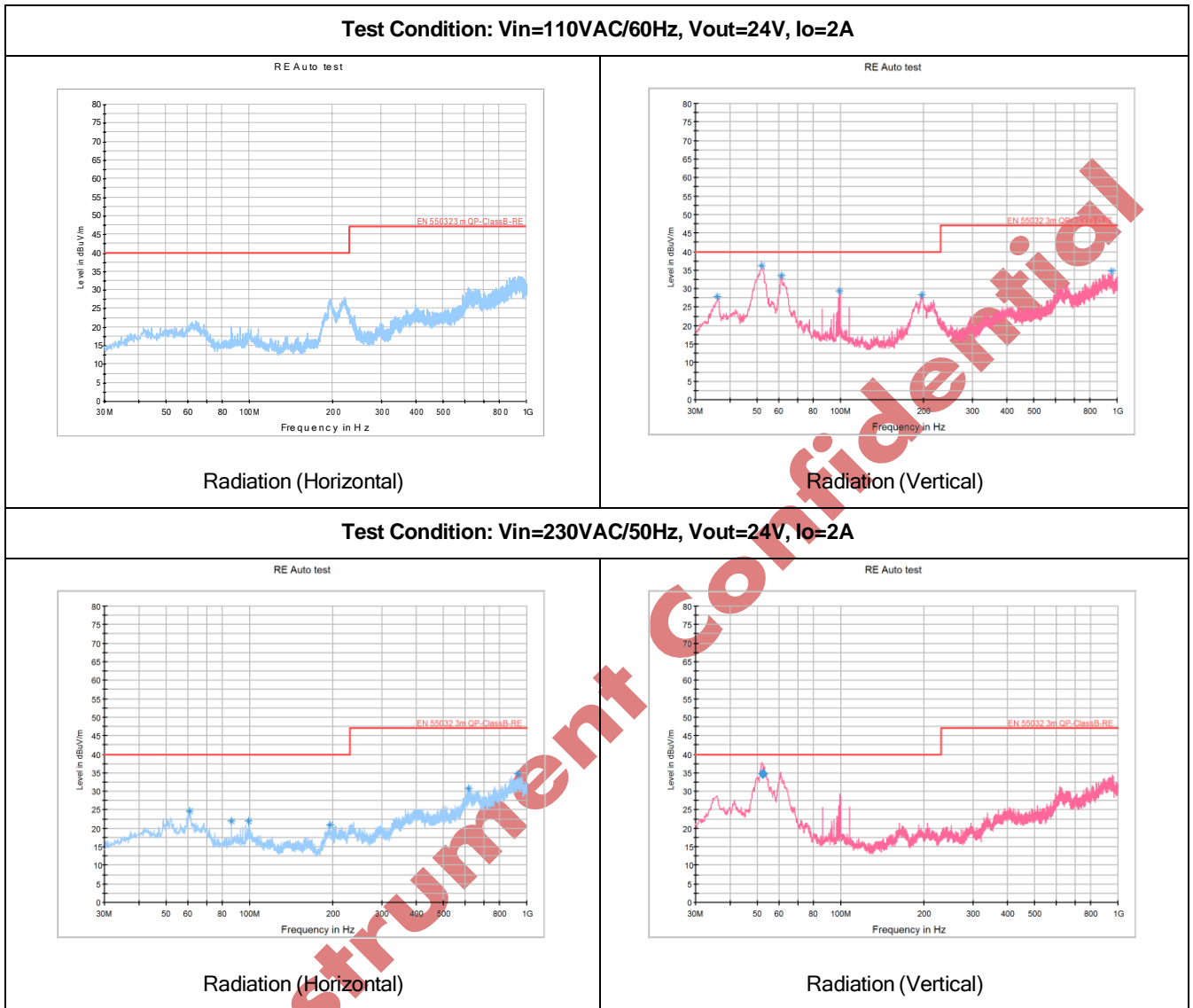

### 5.3 Surge Test

Line to Line 2kV surge testing was completed according to IEC61000-4-5. Input voltage was set at 230VAC/50Hz. Output was loaded at full load and operation was verified following each surge event. Each injection phase below is tested with 5 times and hold for 60 seconds before next one.

Input Voltage (VAC)	Surge Level (V)	Injection Location	Injection Phase (°)	Test Result (Pass/Fail)
230Vac/50Hz	+2000	L to N	0	Pass
	+2000	L to N	90	Pass
	+2000	L to N	180	Pass



	+2000	L to N	270	Pass
	-2000	L to N	0	Pass
	-2000	L to N	90	Pass
	-2000	L to N	180	Pass
	-2000	L to N	270	Pass

#### 5.4 ESD Test

Input 220Vac/50Hz, Output 24V-2A. Discharge 10 times on each output terminals at each test voltage according to IEC61000-4-2

Air Discharge		Contact Discharge	
Test Voltage (kV)	Air Discharge	Test Voltage (kV)	Contact Discharge
14		4	
-14		-4	
15		6	
-15		-6	
16		8	
-16		-8	

#### 5.5 EFT Test

Input 220Vac/50Hz, Output 24V-2A. According to IEC61000-4-4, set EFT pulse as 15ms operation time with every 300ms cycle, Trise=50ns, Thold=50ns, Operation frequency Fsw=5kHz.

Input Voltage (VAC)	EFT Peak Voltage (V)	Injection Location	Frequency(kHz)	Test Result (Pass/Fail)
230Vac/50Hz	+1000	L to N	5	
	+1000	L to N	5	
	-1000	N to L	5	
	-1000	N to L	5	



### 5.6 Voltage Dip Test

Input 220Vac/50Hz, Output 24V-2A. Set voltage dips test according to IEC61000-4-11:2017 as below.

CLASS	Test Level and duration for voltage dips(50 Hz/60 Hz)				
CALSS 3	0% during 1/2 cycle	0% during 1 cycle	40% during 10/12 cycle	70% during 25/30 cycle	80% during 250/300 cycle
25/30 means 25 cycles for 50Hz Test, 30 cycles for 60Hz Test.					

Test Result is classified as below:

A: Normal performance within limits specified by the manufacturer, requestor or purchaser;

B: Temporary loss of function or degradation of performance, which ceases after the disturbance ceases, and from which the equipment under test recovers its normal performance, without operation intervention;

C: Temporary loss of function or degradation of performance, the correction of which requires operator intervention;

D: Loss of function or degradation of performance which is not recoverable, owing to damage to hardware or software, or loss of data.

Test Result: A (A/B/C/D)

**Kiwi Instrument Confidential**





## Test Setup Guide

1. Connect the "V+" and "V-" terminal to the positive and negative end of the load.
2. Set the AC Power Source between 90VAC and 265VAC.
3. Connect the AC Power Source terminal to the "L" and "N" terminals on the Demo Board
4. Turn on the AC Power Source to make system startup; and Turn off the AC Power Source to make system shutdown.

**Kiwi Instrument Confidential**



### Revision History

DATE	REV	DESCRIPTION
2018-09-03	1.0	First Release
2018-09-29	1.1	Updated Schematic and Transformer Winding Information and some Waveforms information .

### Contact Us:

**US  
(Headquarter):**

**Add:** 2060 Walsh Ave, Suite 244,  
Santa Clara, CA, 95050  
**Tel:** 1-+86-18681585060  
**Fax:** 1-408-905-6912  
**E-mail:** marketing@kiwiinst.com

**Hangzhou  
(R&D Center):**

**Add:** Room 1201, Building C, No.581  
HuoJu Rd., Binjiang Dist., Hangzhou,  
P.R.C  
**Tel:** (86) 571-8795-8612  
**Fax:** (86) 571-8795-5363  
**E-mail:** marketing@kiwiinst.com.cn

**Shenzhen  
(Marketing/Field Support):**

**Add:** B302-B303, University  
Creative Park, Xili Rd., Nanshan  
Dist, Shenzhen, P.R.C  
**Tel:** (86) 755-8204-2689  
**Fax:** (86) 755-8204-2192  
**E-mail:** marketing@kiwiinst.com.cn

### Disclaimer

Information that is provided by Kiwi Instruments Corporation is believed to be accurate and reliable. Kiwi instrument reserves the right to make any change in circuit design, specification or other related things if necessary without notice at any time. No third party intellectual property infringement of the applications should be guaranteed by users when integrating Kiwi instrument products into any application. No legal responsibility for any said applications is assumed by Kiwi Instrument.